

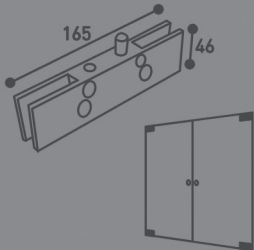





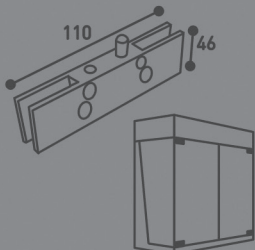

Peças Convencionais

	<p>REFERÊNCIA: <b>101</b></p> <p>DOBRADIÇA PIVOT SUPERIOR COM EIXO A 65MM VIDRO(MM):10 ENTALHE:M101</p>	
	<p>REFERÊNCIA: <b>106</b></p> <p>DOBRADIÇA PIVOT SUPERIOR/INFERIOR COM EIXO A 38MM VIDRO (MM) : 10 ENTALHE : M106</p>	
	<p>REFERÊNCIA: <b>110</b></p> <p>ESQ/DRT DOBRADIÇA PIVOT SUPERIOR COM EIXO A 61MM VIDRO (MM) : 10 ENTALHE : M110</p>	
	<p>REFERÊNCIA: <b>111</b></p> <p>ESQ/DRT DOBRADIÇA PIVOT SUPERIOR VIDRO (MM) : 10 ENTALHE : M112</p>	
	<p>REFERÊNCIA: <b>112</b></p> <p>ESQ/DRT DOBRADIÇA PIVOT INFERIOR VIDRO (MM) : 10 ENTALHE : M112</p>	

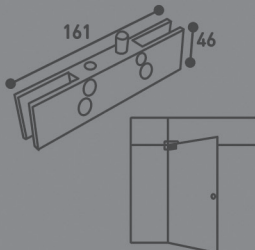

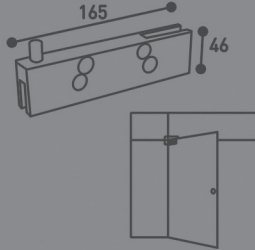
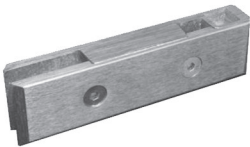
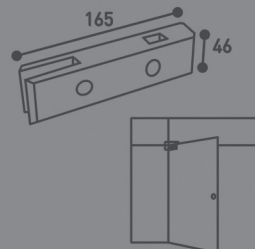
REFERÊNCIA:

**116**

ESQ/DRT  
DOBRADIÇA PIVOT SUPERIOR C/ FIXAÇÃO  
NA ILHARGA  
VIDRO (MM) : 10  
ENTALHE : M 113/M3X/MX

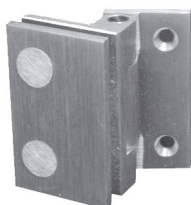
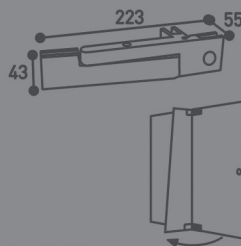

REFERÊNCIA:

**126**

DOBRADIÇA C/ SENTIDO ÚNICO  
DE ABERTURA  
VIDRO (MM) : 8; 10  
ENTALHE : M 126

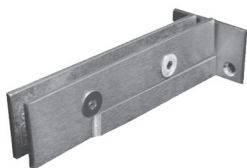
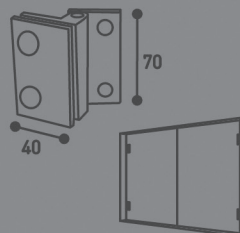

REFERÊNCIA:

**130**

ESQ/DRT  
DOBRADIÇA PIVOT SUPERIOR C/ FIXAÇÃO  
LATERAL  
VIDRO (MM) : 10  
ENTALHE : M 113

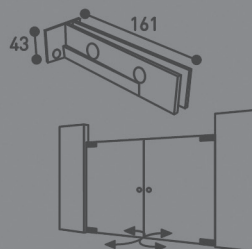

REFERÊNCIA:

**180**

DOBRADIÇA DE VÁSCULA  
ROTAÇÃO 360°  
VIDRO (MM) : 8; 10  
ENTALHE : M 180

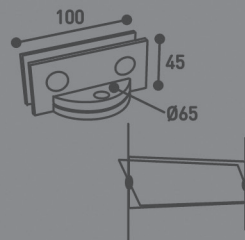

REFERÊNCIA:

**207**

DOBRADIÇA C/ SENTIDO ÚNICO  
VIDRO (MM) : 10  
ENTALHE : M 207/M207A

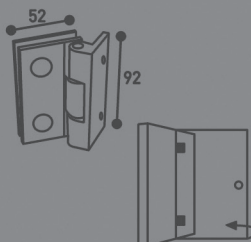



REFERÊNCIA:

## 249

DOBRADIÇA C/ DUPLO SENTIDO  
P/ FIXAÇÃO FRONTAL  
VIDRO (MM): 8  
ENTALHE: M 252

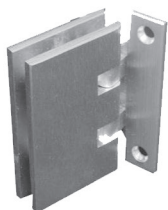
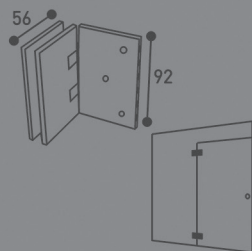

REFERÊNCIA:

## 251

DOBRADIÇA DUPLO SENTIDO  
C/ ABA LATERAL  
VIDRO (MM): 8; 10  
ENTALHE: M 252

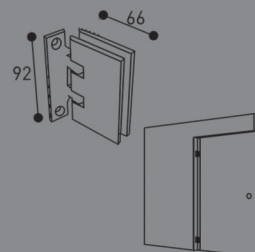

REFERÊNCIA:

## 252

DOBRADIÇA DUPLO SENTIDO  
VIDRO (MM): 8  
ENTALHE: M 252

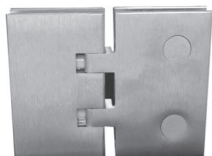
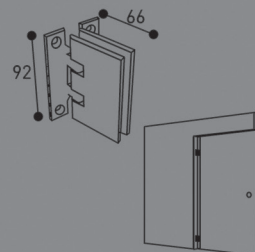

REFERÊNCIA:

## 253

DOBRADIÇA DUPLA C/ DUPLO SENTIDO  
VIDRO (MM): 8  
ENTALHE: M 253A/M253B

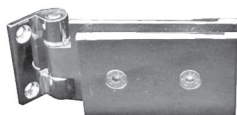
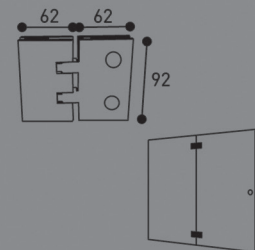

REFERÊNCIA:

## 255

DOBRADIÇA ABERTURA SENTIDO ÚNICO  
VIDRO (MM): 8; 10  
ENTALHE: M 255; M 255A

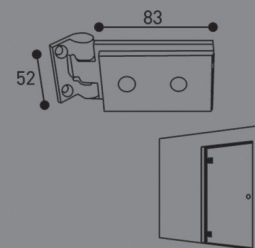



REFERÊNCIA:

**259**

DOBRADIÇA DUPLA A 90°  
C/ DUPLO SENTIDO  
VIDRO (MM) : 8; 10  
ENTALHE : M 259

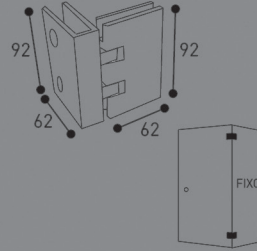

REFERÊNCIA:

**303**

ESQ/DRT  
DOBRADIÇA PIVOT P/ HARMÓNIO C/ EIXO  
A 15MM  
VIDRO (MM) : 10  
ENTALHE : MAC30

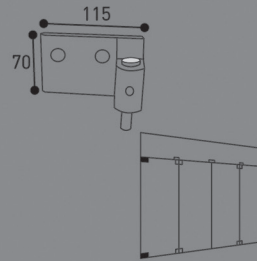

REFERÊNCIA:

**312**

ESQ/DRT  
DOBRADIÇA ARTICULADA P/ HARMÓNIO  
C/ FECHO NO ESPELHO  
VIDRO (MM) : 10  
ENTALHE : MAC30

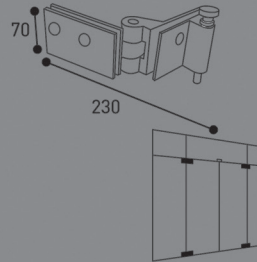

REFERÊNCIA:

**314**

ESQ/DRT  
DOBRADIÇA ARTICULADA P/ HARMÓNIO  
C/ FECHO NA BASE  
VIDRO (MM) : 10  
ENTALHE : MAC30

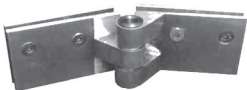
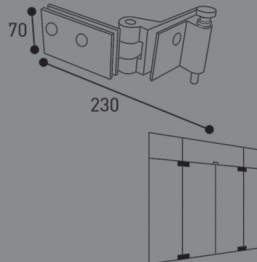

REFERÊNCIA:

**334**

ESQ/DRT  
DOBRADIÇA ARTICULADA P/ HARMÓNIO  
S/ FECHO  
VIDRO (MM) : 10  
ENTALHE : MAC30

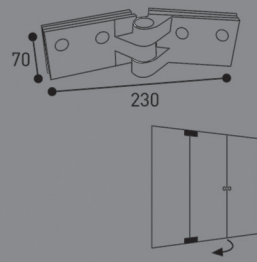



REFERÊNCIA:

## 373

UNIÃO BANDEIRA P/ HARMÔNIO  
C/ FÊMEA P/ DOBRADIÇA REFª 312/314  
VIDRO (MM) : 10  
ENTALHE : M 2X

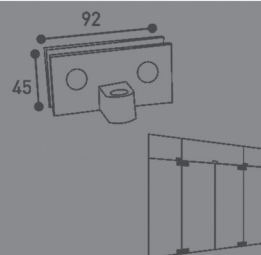

REFERÊNCIA:

## 401

UNIÃO DE BANDEIRA/FIXO  
RECEPTOR DA PEÇA REFª 101  
VIDRO (MM) : 10  
ENTALHE : M 41/2MX

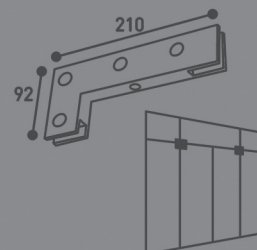

REFERÊNCIA:

## 402

ESQ/DRT  
RECEPTOR DA PEÇA REFª 101 NA  
BANDEIRA C/ FIXAÇÃO LATERAL  
VIDRO(MM):10  
ENTALHE:M41

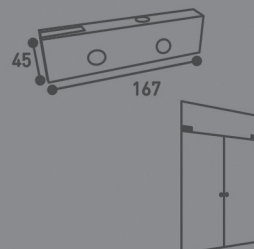

REFERÊNCIA:

## 412

ESQ/DRT  
RECEPTOR DA PEÇA REFª 101 NA  
BANDEIRA C/ CONTRAVENTAMENTO  
VIDRO (MM) : 10  
ENTALHE : M 41/MX

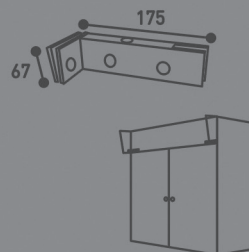

REFERÊNCIA:REFERÊNCIA:

## 414

UNIÃO DE BANDEIRA E ILHARGA A 90º  
P/ INTERIOR E RECEPTOR DA PEÇA  
REFª 110  
VIDRO (MM) : 10  
ENTALHE : M 41/2M3X

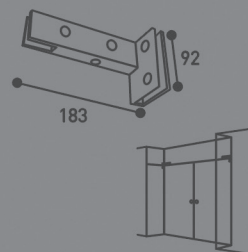



REFERÊNCIA:

**415**

UNIÃO DE BANDEIRA E ILHARGA A 90°  
P/ EXTERIOR RECEPTOR DA PEÇA REFª 110  
VIDRO (MM) : 10  
ENTALHE : M41; 2 M3X (PORTA M 110)

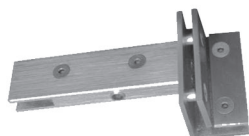
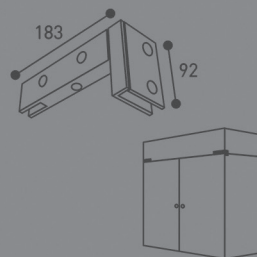

REFERÊNCIA:

**416**

UNIÃO DE BANDEIRA/ILHARGA  
CONTRAVENTAMENTO A 90°  
RECEPTOR DA PEÇA REFª 110  
VIDRO (MM) : 10  
ENTALHE : M 41; 4M X (PORTA M110)

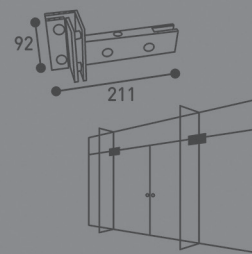

REFERÊNCIA:

**421**

UNIÃO DE BANDEIRA P/ PORTAS DUPLAS  
C/ CONTRAVENTAMENTO E RECEPTOR  
DA PEÇA REFª 110  
VIDRO (MM) : 10

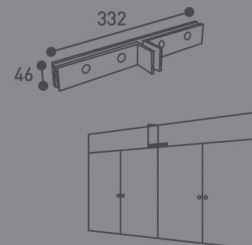

REFERÊNCIA:

**422**

UNIÃO DE BANDEIRA P/ PORTAS DUPLAS  
C/ ILHARGA A 90° E RECEPTOR DA PEÇA  
REFª 110  
VIDRO (MM) : 10  
ENTALHE : 2 M 41; 2 M3X (PORTA M 110)

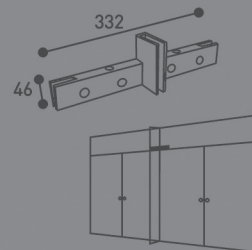

REFERÊNCIA:

**425**

UNIÃO DE BANDEIRA C/ ILHARGA A 90°  
RECEPTOR DA PEÇA REFª 110  
VIDRO (MM) : 10  
ENTALHE : M 41; 2 M 2X

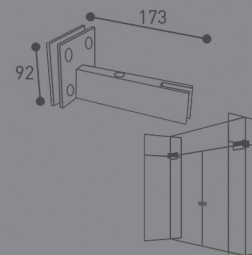



REFERÊNCIA:

**433**

UNIÃO DE BANDEIRA E ILHARGA EM VIDRO LAMINADO C/ CONTRAVENTAMENTO, RECEPTOR DA PEÇA REFª 101  
VIDRO (MM): 10 ENTALHE: M41, MX

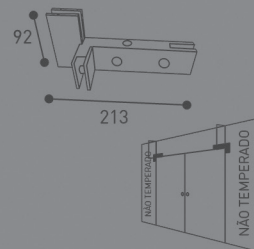

REFERÊNCIA:

**443**

UNIÃO DE BANDEIRA C/ FIXO E CONTRAVENTAMENTO RECEPTOR DA PEÇA REFª 101  
VIDRO (MM) : 10  
ENTALHE : M 41; 3 M X

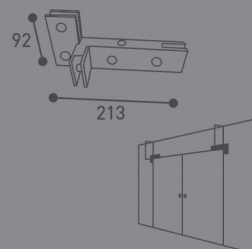

REFERÊNCIA:

**451**

CASQUILHO SUPERIOR P/ TECTO EM VIDRO RECEPTOR DA PEÇA REFª 101/106  
VIDRO(MM):10  
ENTALHE:FØ25MM

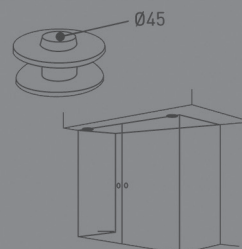

REFERÊNCIA:

**452**

CASQUILHO SUPERIOR RECEPTOR DA PEÇA REFª 101/106  
ENTALHE:FØ10MM

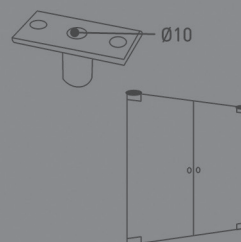

REFERÊNCIA:

**454**

CASQUILHO SUPERIOR RECEPTOR DA PEÇA REFª 303

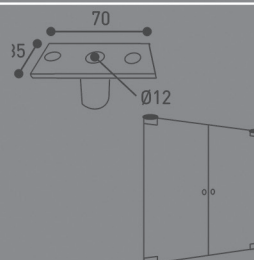





REFERÊNCIA:

**463**

EIXO ROTAÇÃO P/ PAVIMENTO  
RECEPTOR DA PEÇA REFª 1132

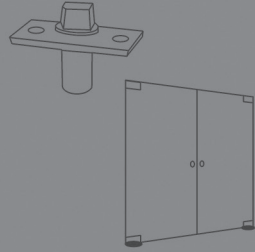

REFERÊNCIA:

**466**

CASQUILHO INFERIOR REDONDO  
RECEPTOR DA PEÇA REFª 101/106

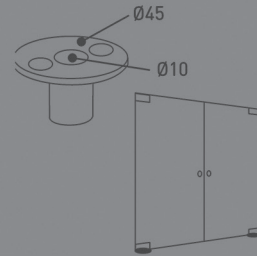

REFERÊNCIA:

**501**

UNIÃO DE ILHARGA E BANDEIRA A 90°  
C/ BATEnte  
VIDRO(MM):10  
ENTALHE:MX/M4X

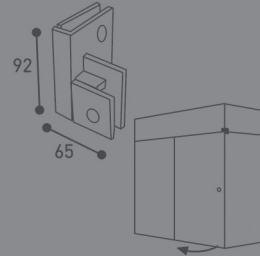

REFERÊNCIA:

**503**

UNIÃO DE ILARGA E BANDEIRA A 90°  
S/ BATEnte  
VIDRO(MM):10  
ENTALHE:MX/M4X

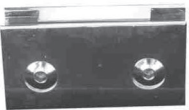
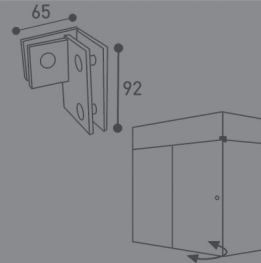

REFERÊNCIA:

**505**

UNIÃO DE VIDROS C/ REMATE  
VIDRO(MM):10  
ENTALHE:M2X

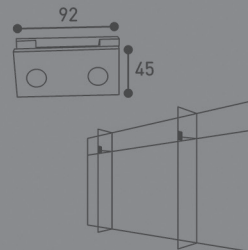



REFERÊNCIA:

## 508

UNIÃO DE 2 A 4 VIDROS A 90°  
VIDRO(MM):10  
ENTALHE:4MX

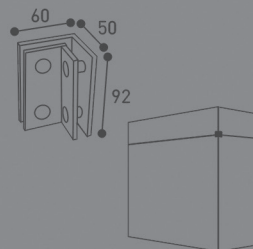

REFERÊNCIA:

## 509

UNIÃO DE 2 VIDROS A 90°  
C/ VIDRO LAMINADO  
VIDRO(MM):10  
ENTALHE:M2X

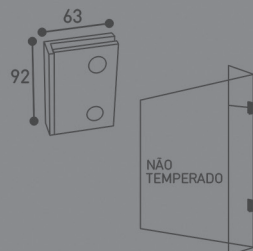

REFERÊNCIA:

## 514

UNIÃO DE 2 A 4 VIDROS  
VIDRO(MM):10  
ENTALHE:M4X

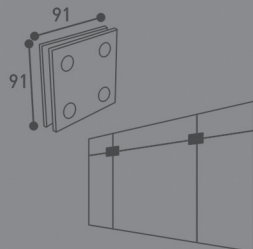

REFERÊNCIA:

## 519

UNIÃO DE 2 A 3 VIDROS  
C/ BATENTE P/ PORTA  
VIDRO(MM):10  
ENTALHE:3MX

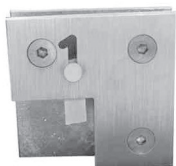
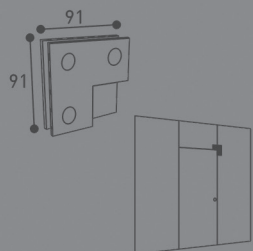

REFERÊNCIA:

## 520

UNIÃO DE 2 A 3 VIDROS  
C/ BATENTE E FECHO P/ PORTA  
VIDRO(MM):10  
ENTALHE:3MX

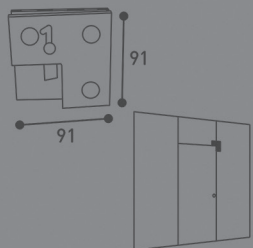



REFERÊNCIA:

**521**

UNIÃO DE 2 A 3 VIDROS  
S/ BATENTE P/ PORTA  
VIDRO(MM):10  
ENTALHE:3MX

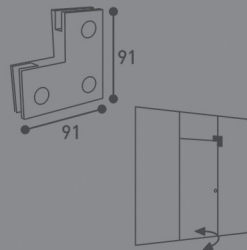

REFERÊNCIA:

**522**

UNIÃO DE 2 A 3 VIDROS  
C/ BATENTE P/ PORTA  
E C/ CONTRAVENTAMENTO  
VIDRO(MM):10  
ENTALHE:4MX

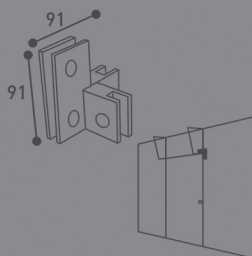

REFERÊNCIA:

**524**

UNIÃO DE 2 A 3 VIDROS  
S/ BATENTE P/ PORTA  
C/ CONTRAVENTAMENTO  
VIDRO(MM):10  
ENTALHE:4MX

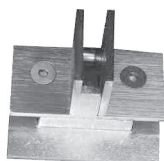
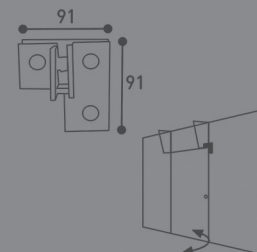

REFERÊNCIA:

**532**

UNIÃO DE VIDROS C/ CONTRAVENTAMENTO  
E BATENTE P/ PORTA DUPLA  
VIDRO(MM):10  
ENTALHE:3MX

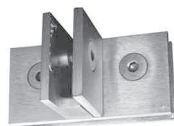
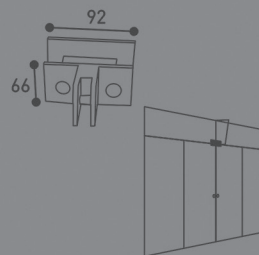

REFERÊNCIA:

**533**

UNIÃO DE 2 VIDROS  
C/ CONTRAVENTAMENTO  
S/ BATENTE P/ PORTAS DUPLAS  
VIDRO(MM):10  
ENTALHE:3MX

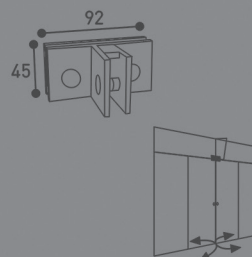



REFERÊNCIA:

## 537

UNIÃO DE 2 VIDROS  
C/ CONTRAVENTAMENTO  
VIDRO(MM):10  
ENTALHE:MX/M67

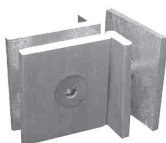
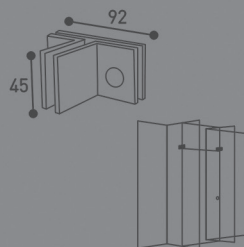

REFERÊNCIA:

## 547

UNIÃO DA ILHARGA/FIXAÇÃO A 90°  
P/ TECTO EM VIDRO  
VIDRO(MM):10  
ENTALHE:M302/FØ22MM

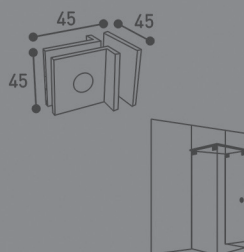

REFERÊNCIA:

## 552

UNIÃO DE LIGAÇÃO/FIXAÇÃO A 90°  
VIDRO(MM):10  
ENTALHE:6MX

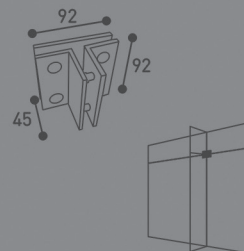

REFERÊNCIA:

## 553

UNIÃO INTERMÉDIA DE VIDROS A 90°  
VIDRO(MM):10  
ENTALHE:M302/M402

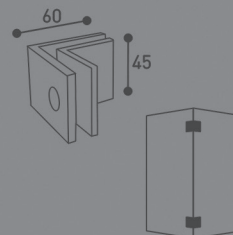



REFERÊNCIA:

## 555

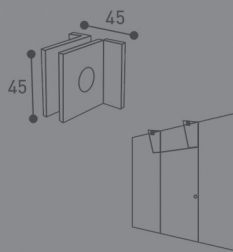
FIXADOR CENTRAL DE VIDRO C/ ABAS  
VIDRO(MM):10  
ENTALHE:M302

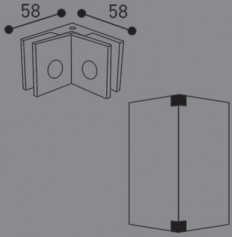
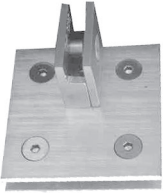
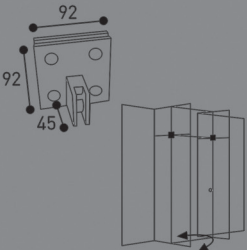

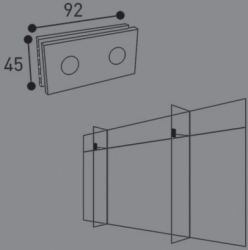
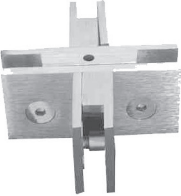
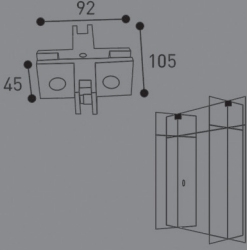
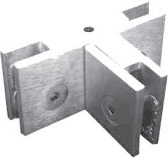
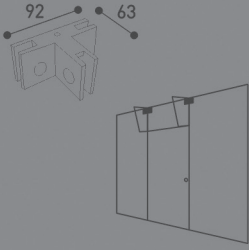
	<p>REFERÊNCIA: <b>556</b> UNIÃO DE VIDROS A 90° VIDRO(MM):10 ENTALHE:M5Y/M6Y</p>	
	<p>REFERÊNCIA: <b>566</b> UNIÃO DE MONTRA C/ CONTRAVENTAMENTO VIDRO(MM):10 ENTALHE:5MX</p>	
	<p>REFERÊNCIA: <b>571</b> UNIÃO INTERMÉDIA DE 2 VIDROS VIDRO(MM):10 ENTALHE:2M302</p>	
	<p>REFERÊNCIA: <b>574</b> UNIÃO DE 4 VIDROS A 90° VIDRO(MM):10 ENTALHE:4MX</p>	
	<p>REFERÊNCIA: <b>580</b> UNIÃO DE 2 A 3 VIDROS C/ CONTRAVENTAMENTO VIDRO(MM):10 ENTALHE:3MX</p>	



REFERÊNCIA:

## 586

FIXAÇÃO DE CANTO P/VIDRO  
VIDRO(MM):10  
ENTALHE:MX

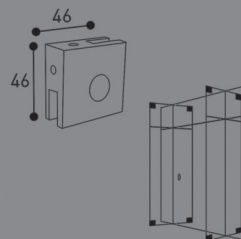

REFERÊNCIA:

## 592

FIXAÇÃO CENTRAL P/VIDRO  
VIDRO(MM):10  
ENTALHE:M302

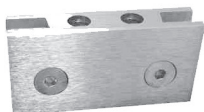
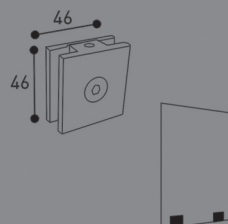

REFERÊNCIA:

## 605

TESTA P/ FECHADURA S/ BATENTE  
VIDRO(MM):10  
ENTALHE:M2X

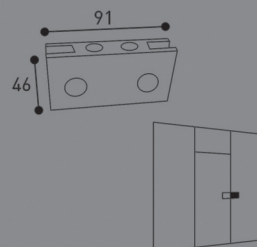

REFERÊNCIA:

## 612

FECHADURA SIMPLES  
CHAVE EM CRUZ  
VIDRO(MM):10  
ENTALHE:M612

712 - 2 FECH.\*  
812 - 3 FECH.\*  
912 - 4 FECH.\*

\* COM CHAVES IGUAIS

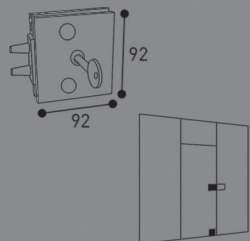

REFERÊNCIA:

## 613

FECHADURA SIMPLES  
CHAVE UNIVERSAL  
VIDRO(MM):10  
ENTALHE:M612

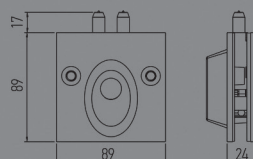



REFERÊNCIA:

**614**

FECHADURA VITRINE  
VIDRO(MM):8/10  
ENTALHE:M612

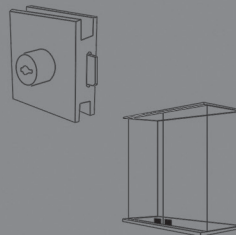

REFERÊNCIA:

**625**

FECHADURA DE TRINCO  
VIDRO(MM):10  
ENTALHE:M625

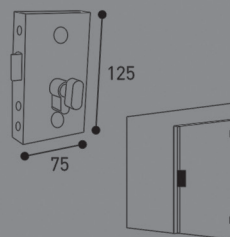

REFERÊNCIA:

**626**

TESTA ELÉCTRICA PARA  
FECHADURA REF°625 C/ TEMPORIZADOR  
VIDRO(MM):10  
ENTALHE:M625

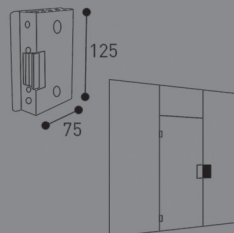

REFERÊNCIA:

**630**

TESTA ELÉCTRICA PARA  
FECHADURA REF°625 C/ TEMPORIZADOR

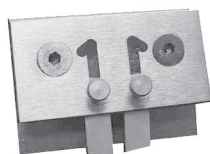
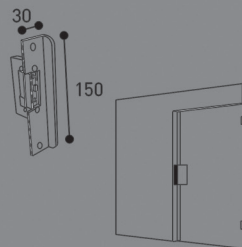

REFERÊNCIA:

**675**

UNIÃO CENTRAL P/ PORTA DUPLA  
C/ BATENTE E FECHO  
VIDRO(MM):10  
ENTALHE:M2X

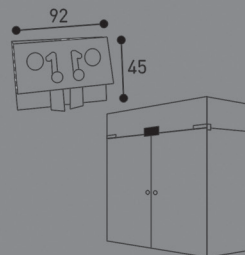

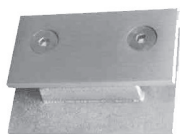

REFERÊNCIA:

**676**

UNIÃO CENTRAL P/ PORTA DUPLA  
C/ BATENTE  
VIDRO(MM):10  
ENTALHE:M2X

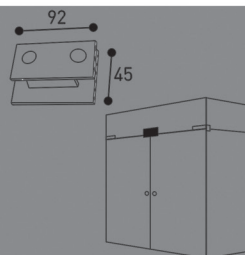

REFERÊNCIA:

**678**

FECHO PEQUENO  
VIDRO(MM):10  
ENTALHE:M678

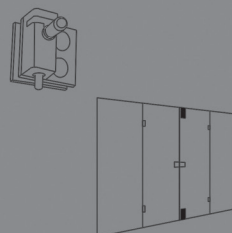

REFERÊNCIA:

**679**

FECHO C/ MOLA  
VIDRO(MM):10  
ENTALHE:M679

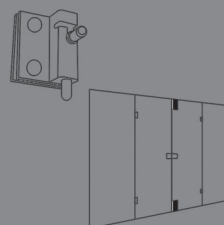

REFERÊNCIA:

**680**

FECHO S/ MOLA  
VIDRO(MM):10  
ENTALHE:M680A

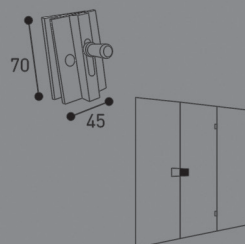

REFERÊNCIA:

**681**

TESTA DO FECHO REFª 680  
VIDRO(MM):10  
ENTALHE:M681

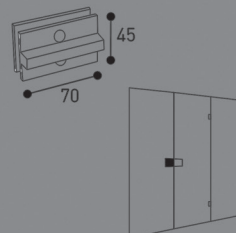





REFERÊNCIA:

**687**

BATENTE P/ PORTA DUPLO  
VIDRO(MM):10  
ENTALHE:M625

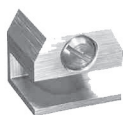
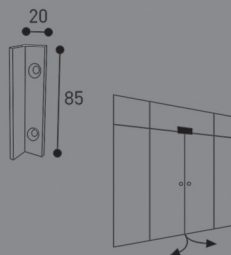

REFERÊNCIA:

**690**

FECHO MOLA S/ ENTALHE

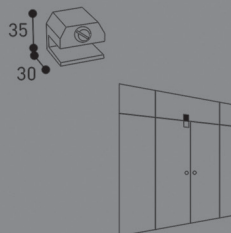

REFERÊNCIA:

**691**

RECEPTOR DA PEÇA REFª 690  
C/BATENTE

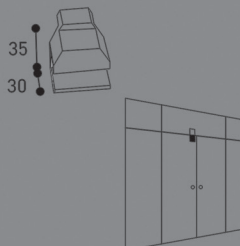

REFERÊNCIA:

**710**

ROLETE DE APOIO P/ FECHADURA  
REFª 612/613

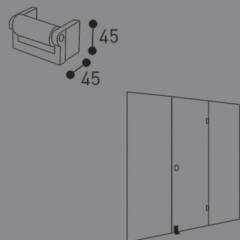

REFERÊNCIA:

**725**

FECHADURA DE TRINCO COM CHAVE  
VIDRO(MM):10  
ENTALHE:M725

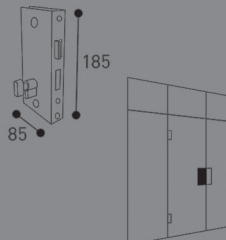



REFERÊNCIA:

## 726

TESTA ELÉCTRICA P/FECHADURA  
REFº725 C/ TEMPORIZADOR  
VIDRO(MM):10  
ENTALHE:M725

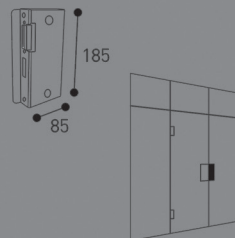

REFERÊNCIA:

## 730

TESTA ELÉCTRICA P/FECHADURA  
REFº725 C/ TEMPORIZADOR  
VIDRO(MM):10  
ENTALHE:M725

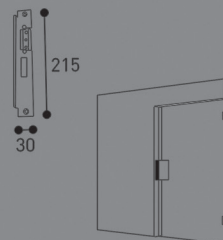

REFERÊNCIA:

## 825

FECHADURA DE TRINCO C/ CHAVE  
VIDRO(MM):10  
ENTALHE:M825

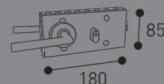

REFERÊNCIA:

## 826

TESTA DA FECHADURA REFº 825  
VIDRO(MM):10  
ENTALHE:M826

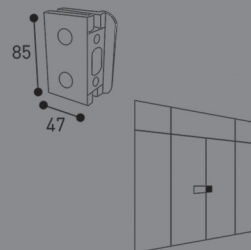

REFERÊNCIA:

## 827

TESTA P/ FECHADURA REFº825

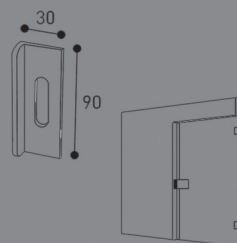



REFERÊNCIA:

**853**

CONJUNTO DE DOBRADIÇA PIVOT  
LATERAL P/ VITRINE  
VIDRO(MM):6/8

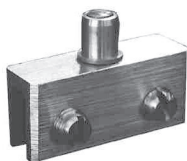
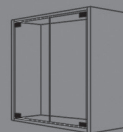
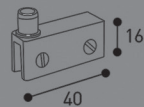

REFERÊNCIA:

**855**

CONJUNTO DE DOBRADIÇA PIVOT  
CENTRAL P/ VITRINE  
VIDRO(MM):6/8

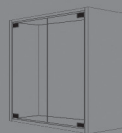
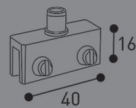

REFERÊNCIA:

**856**

CONJUNTO DE DOBRADIÇA PIVOT  
LATERAL  
VIDRO(MM):8

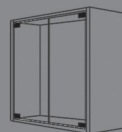
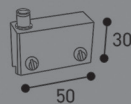

REFERÊNCIA:

**858**

CONJUNTO DE DOBRADIÇA PIVOT  
CENTRAL  
VIDRO(MM):8

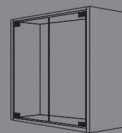
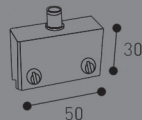

REFERÊNCIA:

**860**

GARRA C/ ABA LATERAL P/ LAMINADO  
VIDRO(MM):8/10

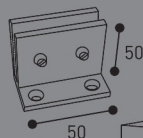



REFERÊNCIA:

## 861

GARRA C/ ABA LATERAL P/ LAMINADO  
VIDRO(MM):6/8

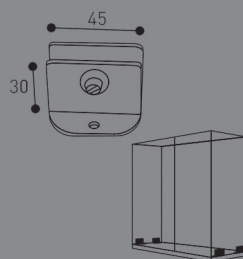

REFERÊNCIA:

## 925

FECHADURA P/ PORTA CORRER  
VIDRO(MM):10  
ENTALHE:M925

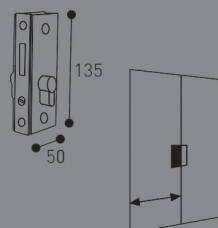

REFERÊNCIA:

## 926

TESTA P/ FECHADURA REFº 925  
VIDRO(MM):10  
ENTALHE:M925

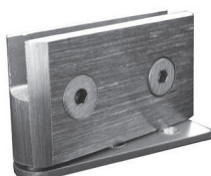
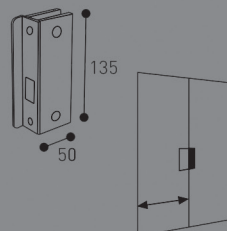

REFERÊNCIA:

## 1122

DOBRADIÇA PIVOT P/ VITRINE  
C/ ENTALHE  
VIDRO(MM):10  
ENTALHE:M122

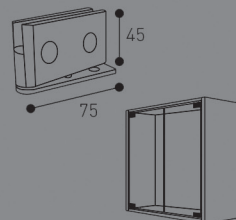

REFERÊNCIA:

## 1124

DOBRADIÇA PIVOT P/ VITRINE C/ ENTALHE  
VIDRO(MM):6  
ENTALHE:M1124

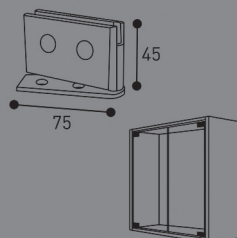



REFERÊNCIA:  
**1132**

DOBRADIÇA PIVOT INFERIOR  
COM EIXO A 65MM  
VIDRO(MM):10  
ENTALHE:M101

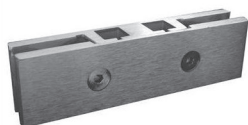
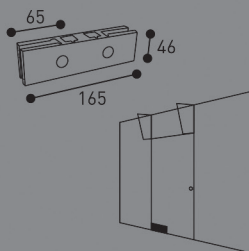

REFERÊNCIA:  
**1133**

DOBRADIÇA PIVOT INFERIOR  
COM EIXO A 61MM  
VIDRO(MM):10  
ENTALHE:M110

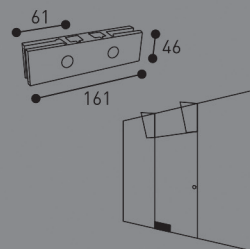

REFERÊNCIA:  
**1134**

DOBRADIÇA DUPLA C/ ROTAÇÃO  
A 180°  
VIDRO(MM):10  
ENTALHE:M1134

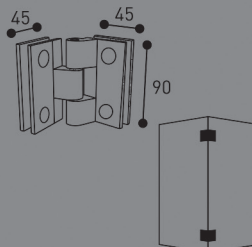

REFERÊNCIA:  
**1204**

DOBRADIÇA DUPLA  
C/ ROTAÇÃO A 180°  
VIDRO(MM):10  
ENTALHE:M1204

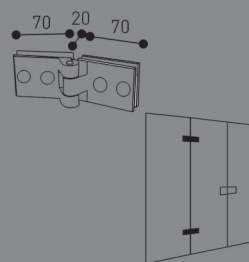

REFERÊNCIA:  
**1207**

DOBRADIÇA C/ ABERTURA DE SENTIDO ÚNICO  
VIDRO(MM):6  
ENTALHE:M1207

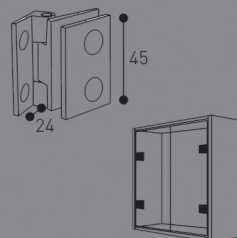

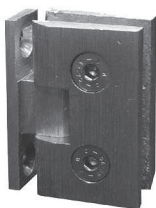

REFERÊNCIA:  
**1251**

DOBRADIÇA C/ ABERTURA DE DUPLO SENTIDO  
VIDRO(MM):6  
ENTALHE:M1251

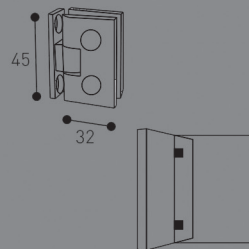

REFERÊNCIA:  
**1303**

DOBRADIÇA PIVOT P/HARMÔNIO  
C/ EIXO CENTRAL  
VIDRO(MM):10  
ENTALHE:M1303

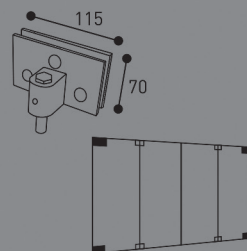

REFERÊNCIA:  
**1505**

TESTA DA FECHADURA REFª 612/613  
C/ BATENTE

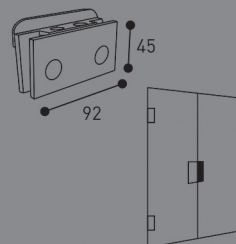

REFERÊNCIA:  
**1600**

TESTA DA FECHADURA  
REFª 2601/2602/2603  
C/ BATENTE

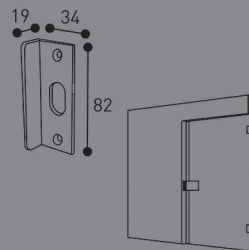

REFERÊNCIA:  
**1612**

TESTA DA FECHADURA REFª 612/613

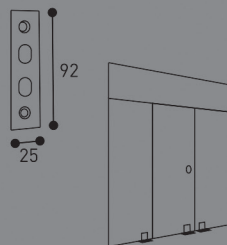

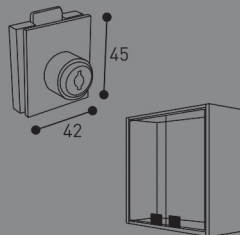

REFERÊNCIA:

**1615**FECHADURA DE VITRINE  
VIDRO(MM):10  
ENTALHE:M1624

REFERÊNCIA:

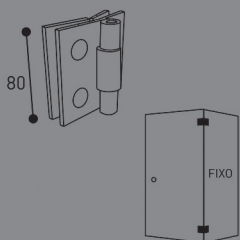
**1624**DOBRADIÇA DUPLA C/ ROTAÇÃO A 180°  
VIDRO(MM):8/10  
ENTALHE:M1624

REFERÊNCIA:

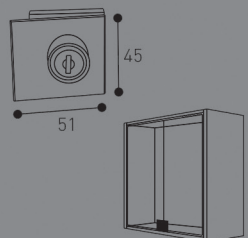
**1625**FECHADURA VITRINE C/ BATENTE  
VIDRO(MM):6/8  
ENTALHE:M1625

REFERÊNCIA:

**1680**

CASQUILHO P/ FECHO REFª 678

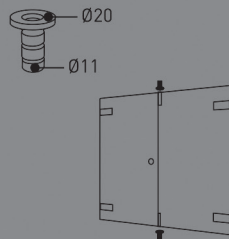

REFERÊNCIA:

**1681**

CASQUILHO P/ FECHO REFª 679

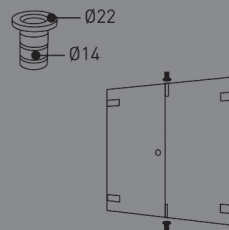



REFERÊNCIA:

## 1687

BATENTE P/ PORTAS SIMPLES

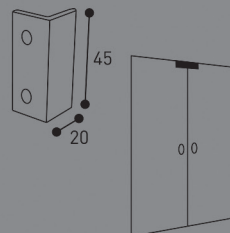

REFERÊNCIA:

## 2101

DOBRADIÇA PIVOT SUPERIOR  
C/ ROTAÇÃO A 180°  
VIDRO(MM):10  
ENTALHE:M101

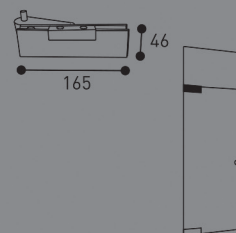

REFERÊNCIA:

## 2132

DOBRADIÇA PIVOT INFERIOR  
C/ ROTAÇÃO A 180°  
VIDRO(MM):10  
ENTALHE:M101

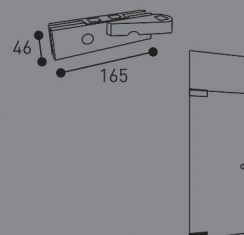

REFERÊNCIA:

## 2401

UNIÃO DE BANDEIRA/FIXO C/ RECEPTOR  
P/ PEÇA REFº 2101  
VIDRO(MM):10  
ENTALHE:M41/2MX

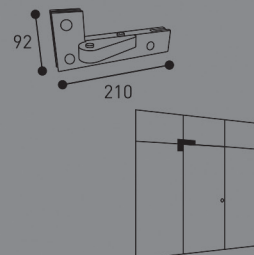

REFERÊNCIA:

## 2402

RECEPTOR DA PEÇA REFº 2101  
BANDEIRA C/ FIXAÇÃO LATERAL  
VIDRO(MM):10  
ENTALHE:M41

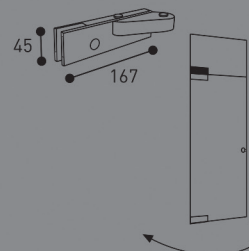





REFERÊNCIA:

**2443**

UNIÃO DE BANDEIRA/FIXO C/ RECEPTOR  
P/ PEÇA REFª2101 C/ CONTRAVENTAMENTO  
VIDRO(MM):10  
ENTALHE:M41/3MX

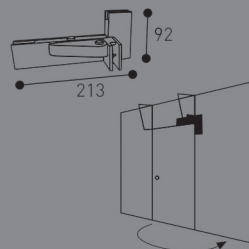

REFERÊNCIA:

**2600**

TESTA DA FECHADURA  
REFª2601/2602/2610 PARA VIDRO  
VIDRO(MM):10  
ENTALHE:M2600

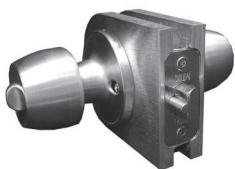
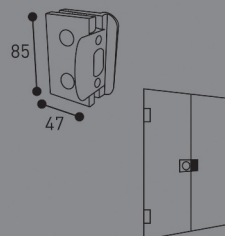

REFERÊNCIA:

**2601**

FECHADURA PUNHO C/ CHAVE  
VIDRO(MM):10  
ENTALHE:M2601

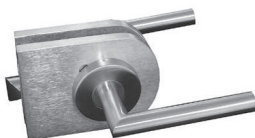
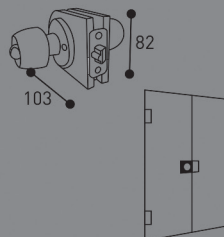

REFERÊNCIA:

**2602**

FECHADURA DE TRINCO  
C/ MULETA S/ CHAVE  
VIDRO(MM):10  
ENTALHE:M2601

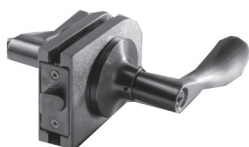
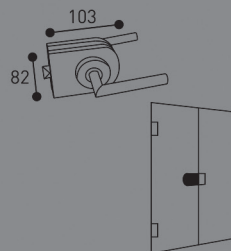

REFERÊNCIA:

**2610**

FECHADURA DE MULETA C/ CHAVE  
VIDRO(MM):10  
ENTALHE:M2601

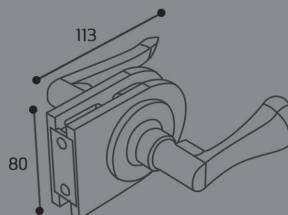



REFERÊNCIA:

## 2612

TESTA DA FECHADURA REFª 612  
PARA VIDRO  
VIDRO(MM):10  
ENTALHE:M612

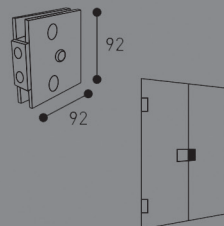

REFERÊNCIA:

## 2678

TESTA DO FECHO REFª 678  
P/BANDEIRA  
VIDRO(MM):10  
ENTALHE:M678

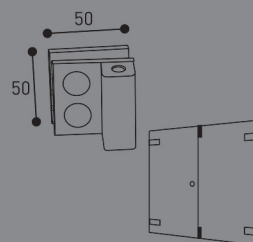

REFERÊNCIA:

## 2679

TESTA DO FECHO REFª 679  
P/BANDEIRA  
VIDRO(MM):10  
ENTALHE:M679

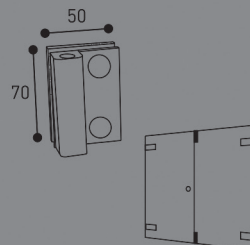

REFERÊNCIA:

## 3612

FECHADURA DE CHAVE  
CRUZ S/ ENTALHE

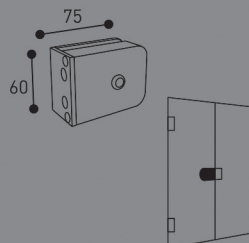

REFERÊNCIA:

## 3710

ROLETE DE APOIO DE VIDRO S/ ENTALHE  
VIDRO(MM):10

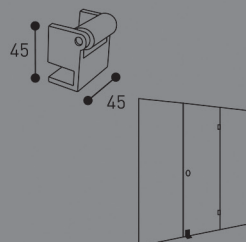



REFERÊNCIA:

**4612**

TESTA DA FECHADURA REFº 3612  
P/VIDRO S/ENTALHE

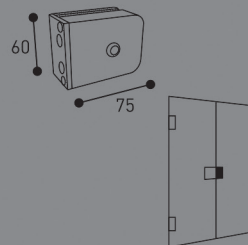

REFERÊNCIA:

**5000**

UNIÃO DE FIXAÇÃO C/ ABA  
VIDRO(MM):10  
ENTALHE:M2X

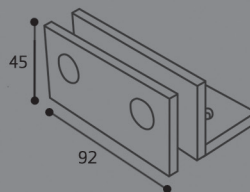

REFERÊNCIA:

**5001**

UNIÃO DE FIXAÇÃO  
VIDRO(MM):10  
ENTALHE:M2X

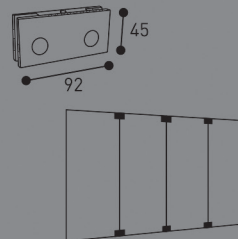

REFERÊNCIA:

**5002**

SUPORE P/ PORTAS CORRER S/ CARRO  
VIDRO(MM):10  
ENTALHE:M5002

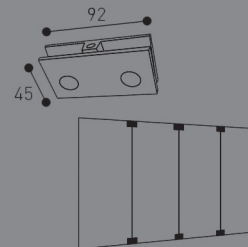

REFERÊNCIA:

**5039**

UNIÃO DE VIDROS EM CANTO  
VIDRO(MM):10  
ENTALHE:M6X/M3X/MX

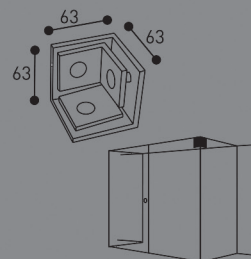



REFERÊNCIA:

## 5049

PEÇA DE FIXAÇÃO À BANDEIRA C/ BATENTES  
VIDRO(MM):10  
ENTALHE:MX

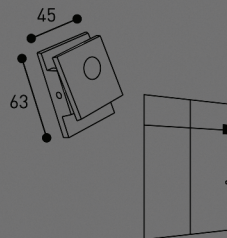

REFERÊNCIA:

## 5612

5712 - 2 MEC.\*

5812 - 3 MEC.\*

5912 - 4 MEC.\*

MECANISMO DE FECHADURA  
\*INDICAR QTD

\* COM CHAVES IGUAIS



REFERÊNCIA:

## 6001

SUPORTE P/ PORTA DE CORRER S/ CARRO  
VIDRO(MM):10  
ENTALHE:M6001

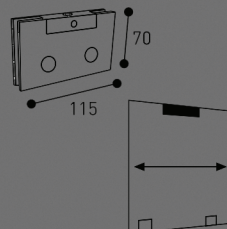

REFERÊNCIA:

## 6012

ROLETE DUPLO C/ ENTALHE  
VIDRO(MM):10  
ENTALHE:M6013

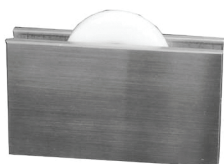
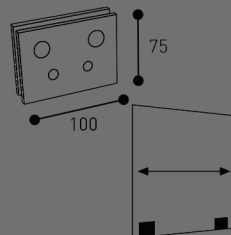

REFERÊNCIA:

## 6013

ROLETE C/ ENTALHE  
VIDRO(MM):10  
ENTALHE:M6013

